



Photocoupler
Product Data Sheet
LTV-356T

Spec No. :DS70-2001-010
Effective Date: 10/04/2018
Revision: P

LITE-ON DCC

RELEASE

BNS-OD-FC001/A4

Photocoupler LTV-356T series

1. DESCRIPTION

1.1 Features

- Current transfer ratio (CTR : 50% to 600% at $I_F = 5\text{mA}$, $V_{CE} = 5\text{V}$)
- High input-output isolation voltage ($V_{iso} = 3,750\text{Vrms}$)
- High collector-emitter voltage ($V_{CEO} = 80\text{V}$)
- Mini-flat package : LTV-356T
- Safety approval
 - UL 1577
 - VDE DIN EN60747-5-5 (VDE 0884-5) ,
 - CSA CA5A
 - CQC GB4943.1-2011/ GB8898-2011
 - FIMKO/DEMKO/SEMKO/NEMKO
- RoHS Compliance
 - All materials be used in device are followed EU RoHS directive (No.2002/95/EC, 2011/65/EU, and 2015/863).
- ESD pass HBM 8000V/ MM2000V/ CDM2000V
- MSL class1
- Halogen Free option

1.2 Applications

- Hybrid substrates that require high density mounting.
- Programmable controllers
- System appliance, measuring instruments

Photocoupler LTV-356T series

2. PACKAGE DIMENSIONS

2.1 LTV-356T series

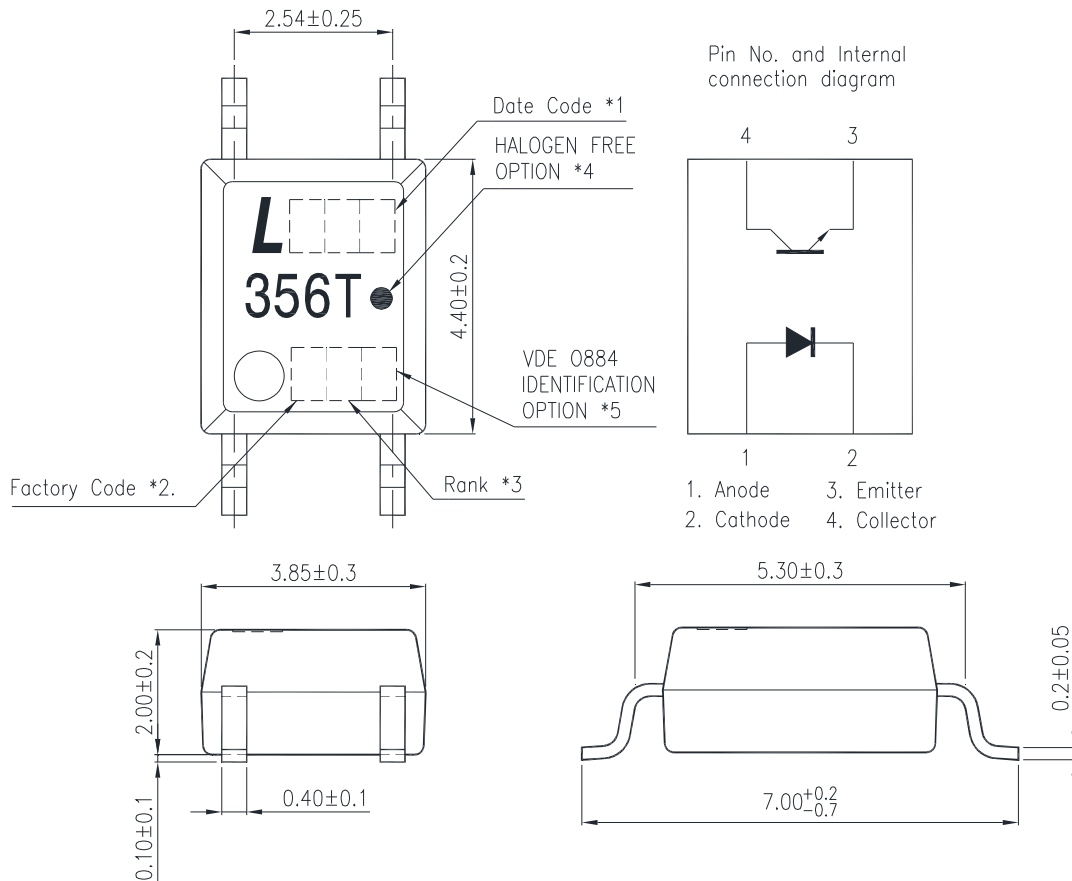

Notes :

- 1-digit year code, Example : 2010 = A
2-digit work week ranging from '01' to '53'
- Factory identification mark shall be marked (W: China -CZ, X: China -TJ)
- Rank shall be or shall not be marked.
- “●” indicates halogen free option.
- “V” for VDE option.

*All dimensions in millimeters.

Photocoupler LTV-356T series

3. TAPING DIMENSIONS

3.1 LTV-356T-TP



3.2 LTV-356T (no suffix)

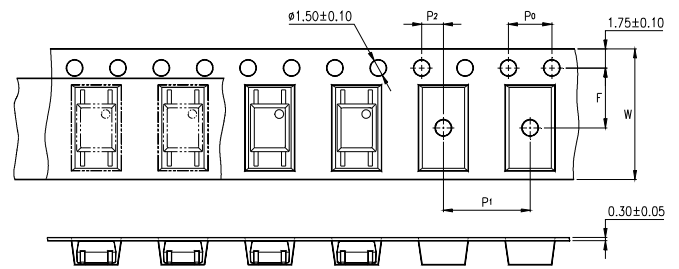

Description	Symbol	Dimension in mm (inch)
Tape wide	W	12±0.3 (0.472)
Pitch of sprocket holes	P_0	4±0.1 (0.157)
Distance of compartment	F	5.5±0.1 (0.217)
	P_2	2±0.1 (0.079)
Distance of compartment to compartment	P_1	8±0.1 (0.315)

3.3 Quantities Per Reel

Package Type	LTV-356T series
Quantities (pcs)	3000

Photocoupler LTV-356T series

4. RATING AND CHARACTERISTICS

4.1 Absolute Maximum Ratings at Ta=25°C

	Parameter	Symbol	Rating	Unit
Input	Forward Current	I_F	50	mA
	Reverse Voltage	V_R	6	V
	Power Dissipation	P	70	mW
	Junction Temperature	T_J	125	°C
Output	Collector - Emitter Voltage	V_{CEO}	80	V
	Emitter - Collector Voltage	V_{ECO}	6	V
	Collector Current	I_C	50	mA
	Collector Power Dissipation	P_C	150	mW
	Junction Temperature	T_J	125	°C
	Total Power Dissipation	P_{tot}	170	mW
1.	Isolation Voltage	V_{iso}	3750	V_{rms}
	Operating Temperature	T_{opr}	-55 ~ +110	°C
	Storage Temperature	T_{stg}	-55 ~ +150	°C
2.	Soldering Temperature	T_{sol}	260	°C

1. AC For 1 Minute, R.H. = 40 ~ 60%

Isolation voltage shall be measured using the following method.

- (1) Short between anode and cathode on the primary side and between collector and emitter on the secondary side.
- (2) The isolation voltage tester with zero-cross circuit shall be used.
- (3) The waveform of applied voltage shall be a sine wave.

2. For 10 Seconds

Photocoupler LTV-356T series

4.2 ELECTRICAL OPTICAL CHARACTERISTICS at Ta=25°C

Parameter		Symbol	Min.	Typ.	Max.	Unit	Test Condition
Input	Forward Voltage	V_F	—	1.2	1.4	V	$I_F=20\text{mA}$
	Reverse Current	I_R	—	—	10	μA	$V_R=4\text{V}$
	Terminal Capacitance	C_t	—	30	250	pF	$V=0, f=1\text{KHz}$
Output	Collector Dark Current	I_{CEO}	—	—	100	nA	$V_{CE}=20\text{V}, I_F=0$
	Collector-Emitter Breakdown Voltage	BV_{CEO}	80	—	—	V	$I_C=0.1\text{mA}, I_F=0$
	Emitter-Collector Breakdown Voltage	BV_{ECO}	6	—	—	V	$I_E=10\mu\text{A}, I_F=0$
TRANSFER CHARACTERISTICS	Collector Current	I_C	2.5	—	30	mA	$I_F=5\text{mA}$
	1. Current Transfer Ratio	CTR	50	—	600	%	$V_{CE}=5\text{V}$
	Collector-Emitter Saturation Voltage	$V_{CE(sat)}$	—	—	0.2	V	$I_F=20\text{mA}$ $I_C=1\text{mA}$
	Isolation Resistance	R_{iso}	5×10^{10}	1×10^{11}	—	Ω	DC500V, 40 ~ 60% R.H.
	Floating Capacitance	C_f	—	0.6	1	pF	$V=0, f=1\text{MHz}$
	Response Time (Rise)	t_r	—	4	18	μs	$V_{CE}=2\text{V},$ $I_C=2\text{mA}$
	Response Time (Fall)	t_f	—	3	18	μs	$R_L=100\Omega,$

$$1. \text{CTR} = \frac{I_C}{I_F} \times 100\%$$

**Photocoupler
LTV-356T series**

5. RANK TABLE OF CURRENT TRANSFER RATIO (CTR)

Parameter	CTR Rank	Min	Max	Condition
DC Current Transfer Ratio	A	80	160	$I_F=5\text{mA}$, $V_{CE}=5\text{V}$, $T_a=25^\circ\text{C}$
	B	130	260	
	C	200	400	
	D	300	600	
	A or B or C or D or No mark	50	600	

Photocoupler LTV-356T series

6. CHARACTERISTICS CURVES (TYPICAL PERFORMANCE)

Fig.1 Forward Current vs. Ambient Temperature

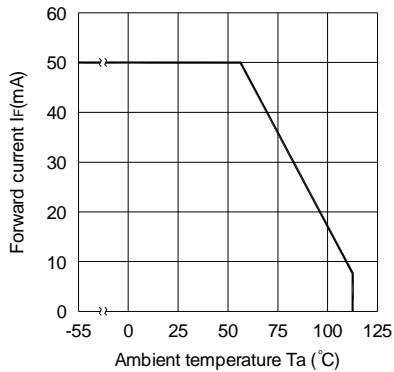

Fig.2 Collector Power Dissipation vs. Ambient Temperature

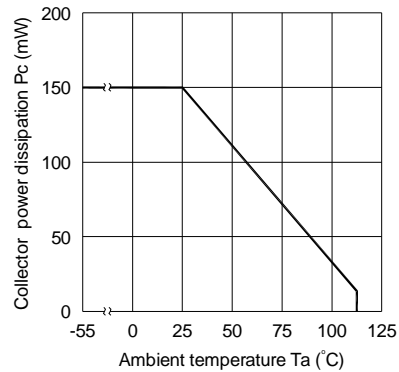

Fig.3 Collector-emitter Saturation Voltage vs. Forward Current

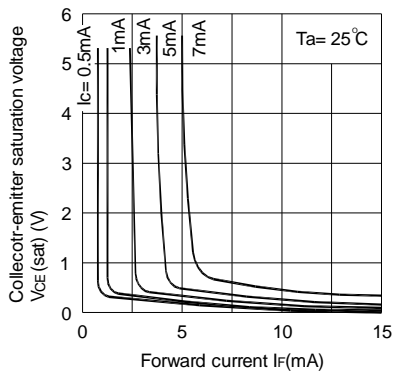

Fig.4 Forward Current vs. Forward Voltage

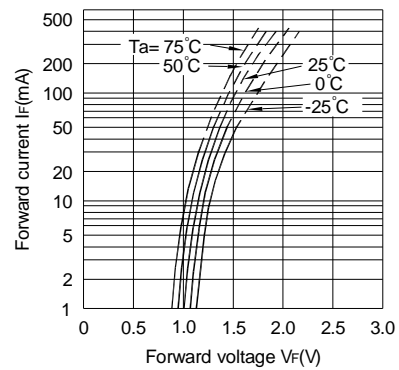

Fig.5 Current Transfer Ratio vs. Forward Current

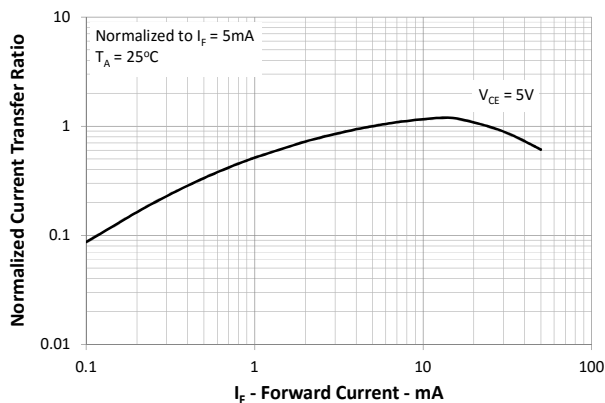
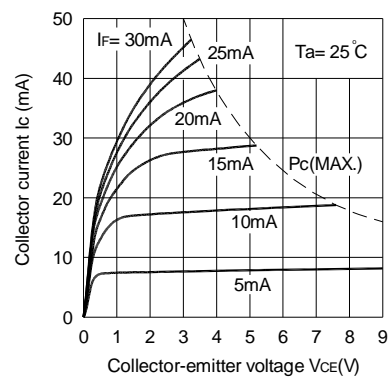

Fig.6 Collector Current vs. Collector-emitter Voltage



Photocoupler LTV-356T series

Fig.7 Relative Current Transfer Ratio vs. Ambient Temperature

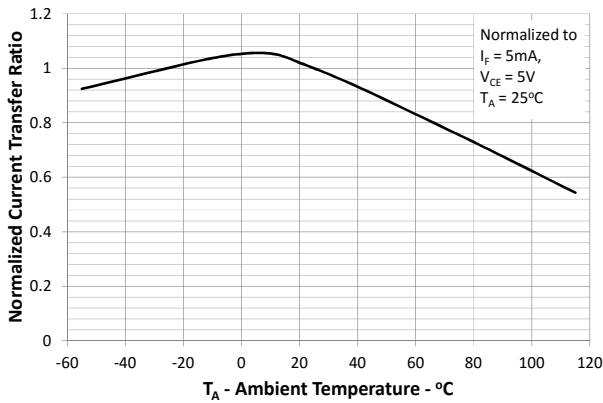

Fig.8 Collector-emitter Saturation Voltage vs. Ambient Temperature

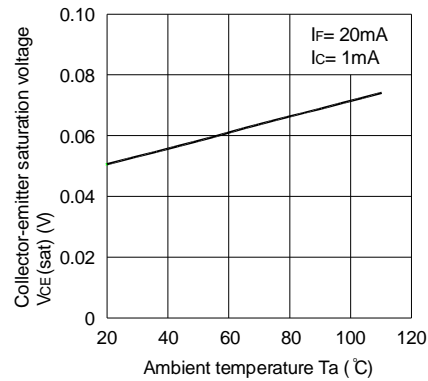

Fig.9 Collector Dark Current vs. Ambient Temperature

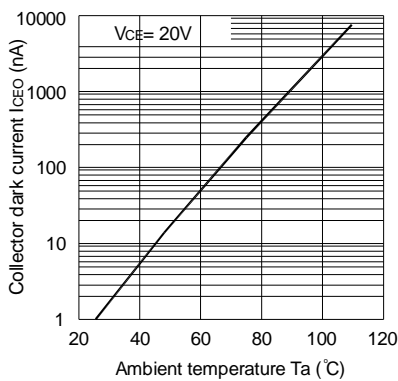

Fig.10 Response Time vs. Load Resistance

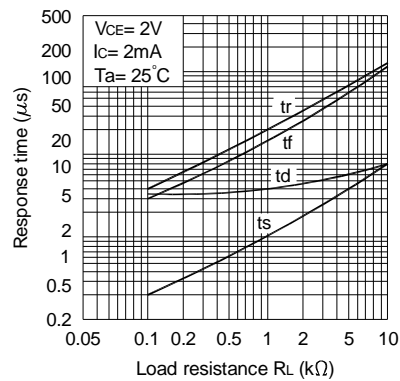
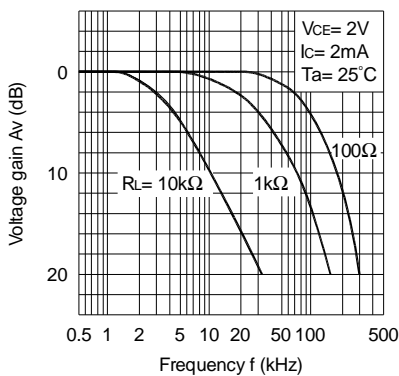
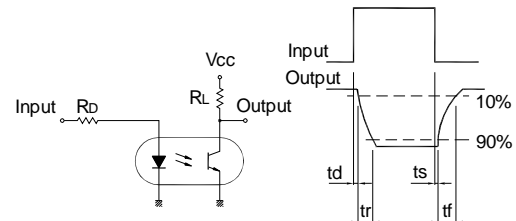

Fig.11 Frequency Response



Test Circuit for Response Time



Test Circuit for Frequency Response

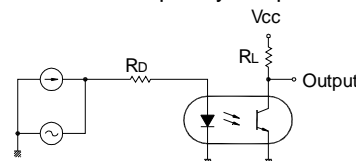

Photocoupler LTV-356T series

7. TEMPERATURE PROFILE OF SOLDERING

7.1 IR Reflow soldering (JEDEC-STD-020C compliant)

One time soldering reflow is recommended within the condition of temperature and time profile shown below. Do not solder more than three times.

Profile item	Conditions
Preheat	
- Temperature Min (T_{Smin})	150°C
- Temperature Max (T_{Smax})	200°C
- Time (min to max) (ts)	90±30 sec
Soldering zone	
- Temperature (T_L)	217°C
- Time (t_L)	60 ~ 100 sec
Peak Temperature (T_P)	260°C
Ramp-up rate	3°C / sec max.
Ramp-down rate	3~6°C / sec

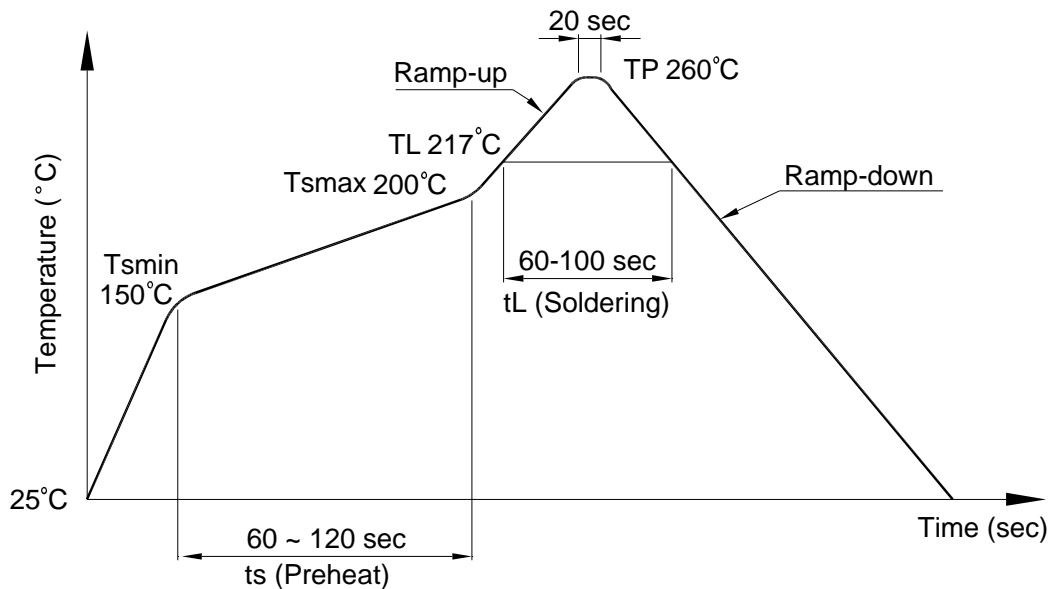

**Photocoupler
LTV-356T series**

7.2 Wave soldering (JEDEC22A111 compliant)

One time soldering is recommended within the condition of temperature.

Temperature: $260 \pm 0 / -5^{\circ}\text{C}$

Time: 10 sec.

Preheat temperature: 25 to 140°C

Preheat time: 30 to 80 sec.

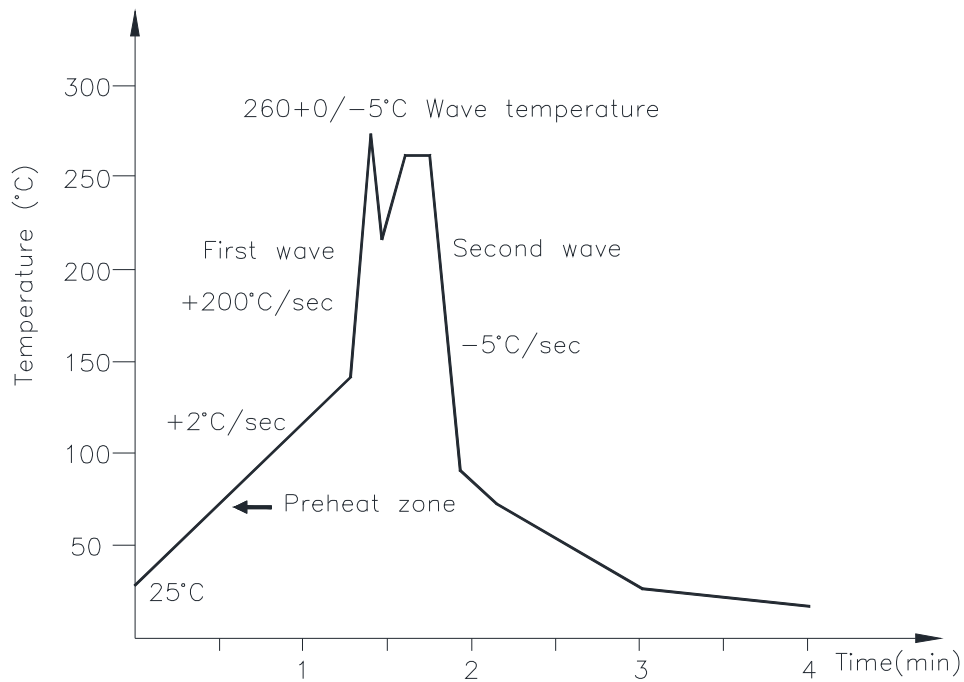

7.3 Hand soldering by soldering iron

Allow single lead soldering in every single process. One time soldering is recommended.

Temperature: $380 \pm 0 / -5^{\circ}\text{C}$

Time: 3 sec max.

Photocoupler
LTV-356T series

8. RECOMMENDED FOOT PRINT PATTERNS (MOUNT PAD)

Unit: mm

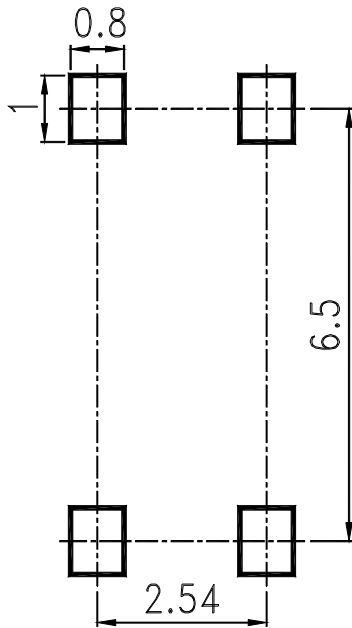

**Photocoupler
LTV-356T series**

9. NAMING RULE

LTV-356T-(1)-(2)-G

DEVICE PART NUMBER

(1) TAPING TYPE (TP or no suffix)

LTV-356T has tape and reel solution.

Please refer to orientation of taping on Page P3

(2) CTR RANK

Please refer to Page P6

(3) Halogen free option

Example : LTV-356T-TP-A-G

LTV 356T (1) (2)-V-G

DEVICE PART NUMBER

(1) TAPING TYPE (TP or no suffix)

LTV-356T has tape and reel solution.

Please refer to orientation of taping on Page P3

(2) CTR RANK

Please refer to Page P6

(3) VDE option

(4) Halogen free option

Example : LTV356TTPA-V-G

10. NOTES

- LiteOn is continually improving the quality, reliability, function or design and LiteOn reserves the right to make changes without further notices.
- The products shown in this publication are designed for the general use in electronic applications such as office automation equipment, communications devices, audio/visual equipment, electrical application and instrumentation.
- For equipment/devices where high reliability or safety is required, such as space applications, nuclear power control equipment, medical equipment, etc, please contact our sales representatives.
- When requiring a device for any "specific" application, please contact our sales in advice.
- If there are any questions about the contents of this publication, please contact us at your convenience.
- The contents described herein are subject to change without prior notice.
- Immerge unit's body in solder paste is not recommended.